

# DERELİ

ALÜMİNYUM A.Ş.

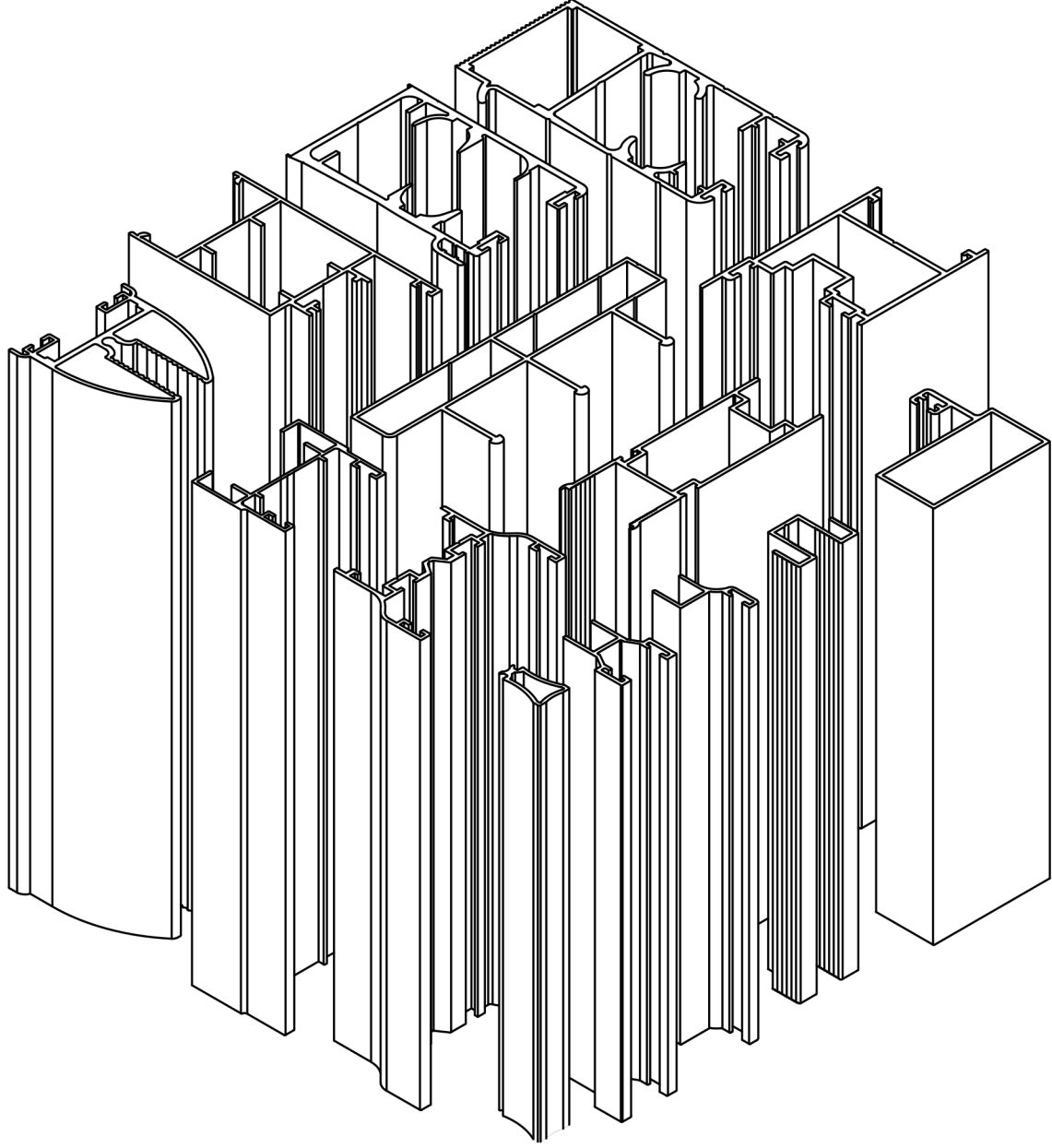

UPDOWN HAREKETLİ CAM SİSTEMLERİ  
Platin 8 MM Katlanır Cam Balkon

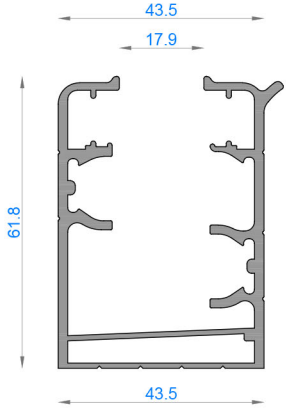

Profil Kod: 1601

Ağırlık (kg/mt) 1,325

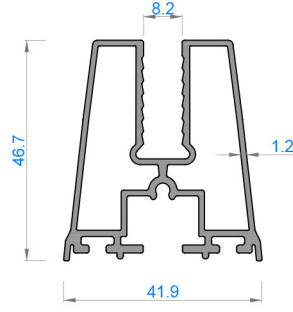

Profil Kod: 1602

Ağırlık (kg/mt) 0,950

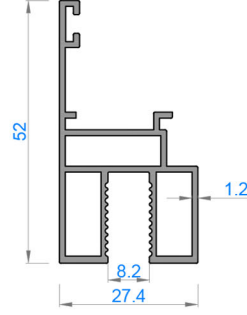

Profil Kod: 1603

Ağırlık (kg/mt) 0,596

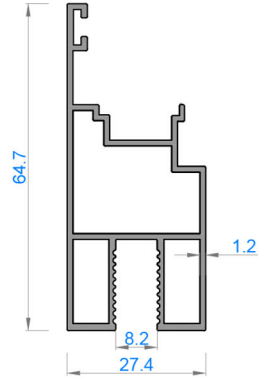

Profil Kod: 1604

Ağırlık (kg/mt) 0,712

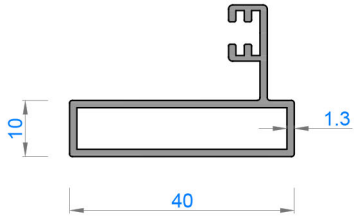

Profil Kod: 4827

Ağırlık (kg/mt) 0,448

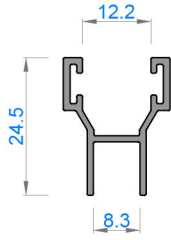

Profil Kod: 4826

Ağırlık (kg/mt) 0,221

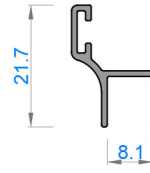





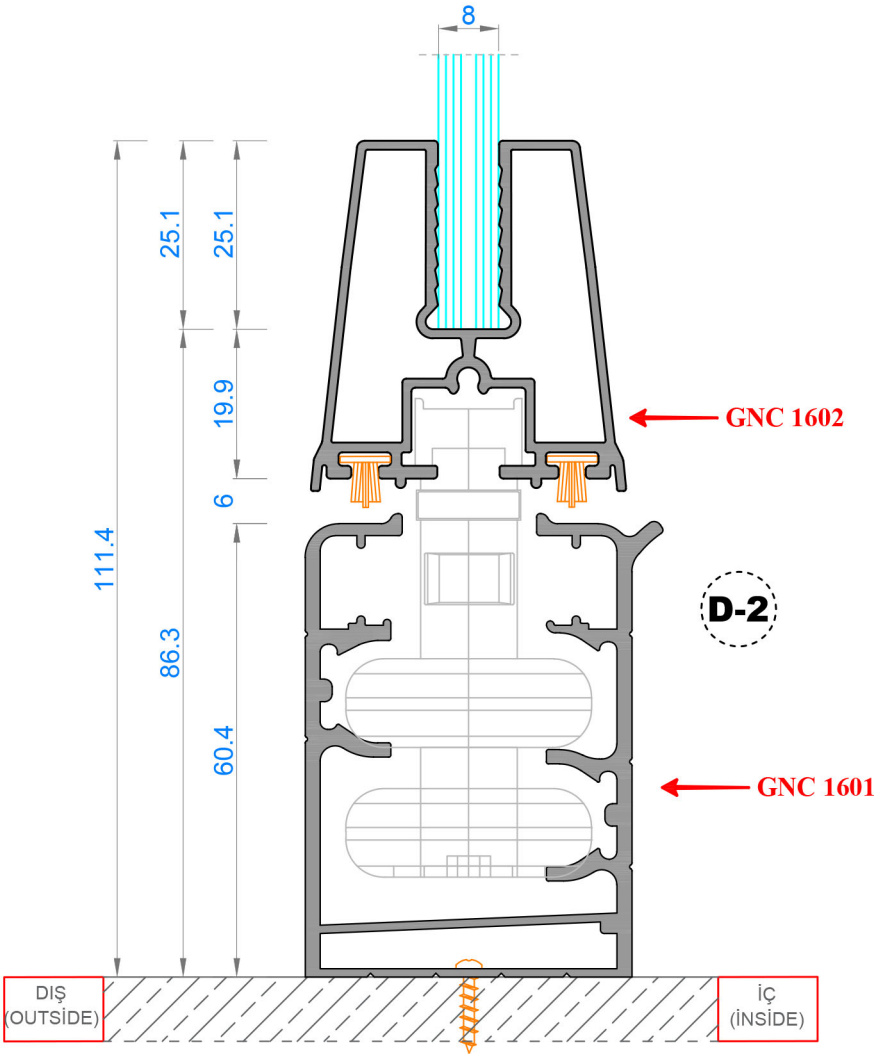
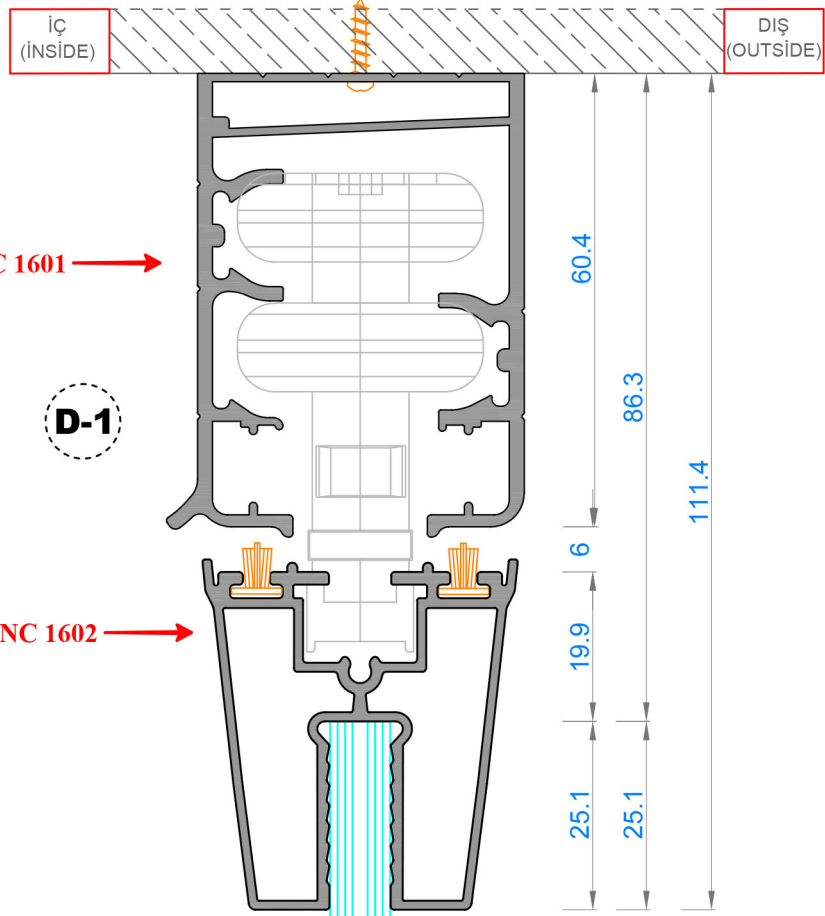
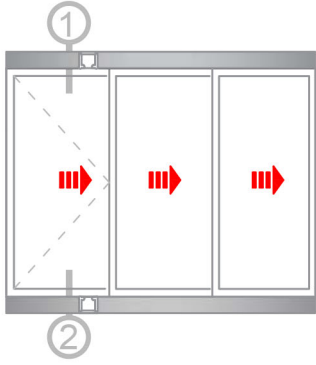

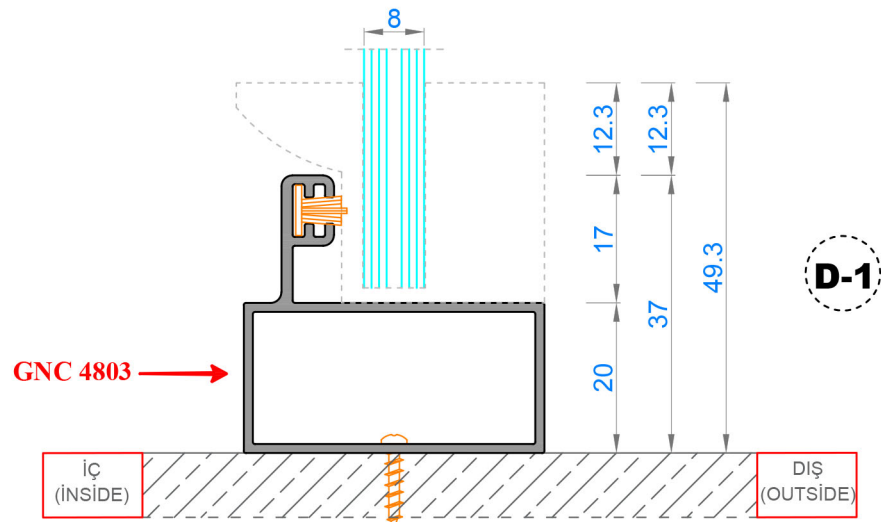
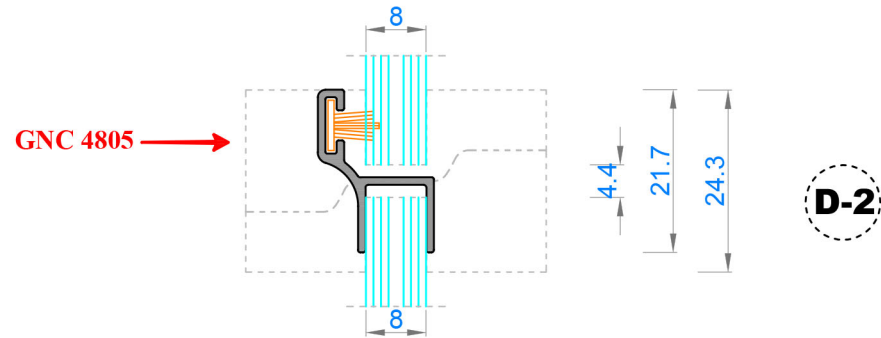
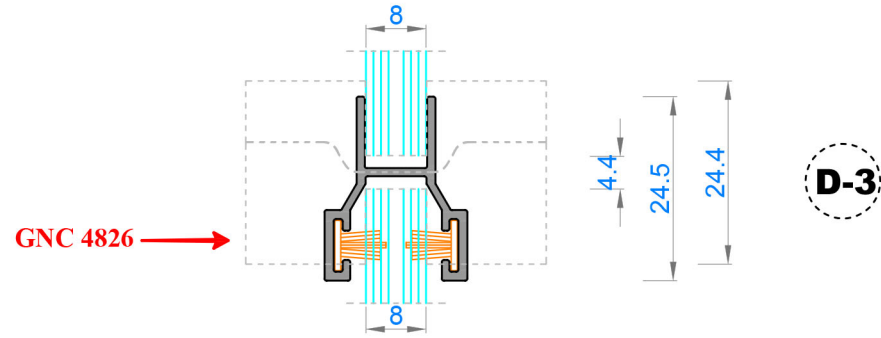
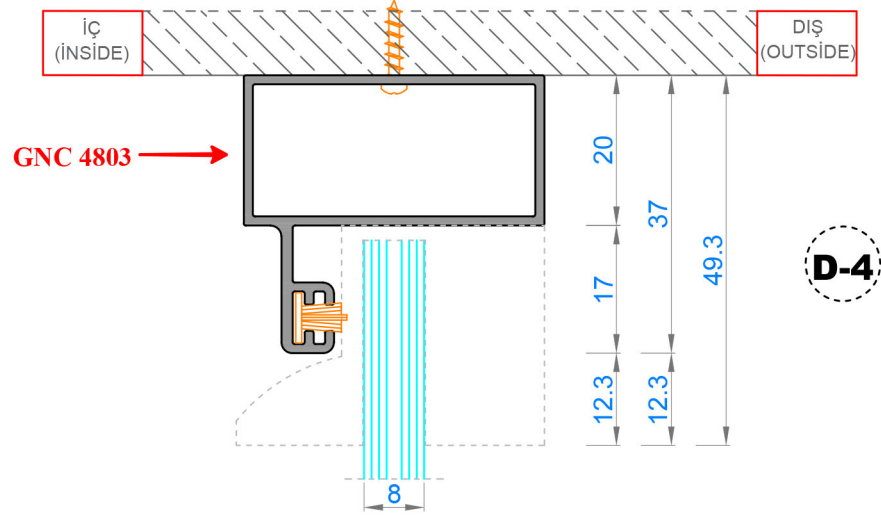
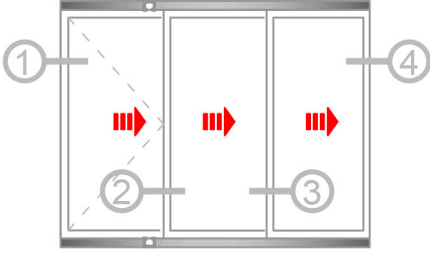

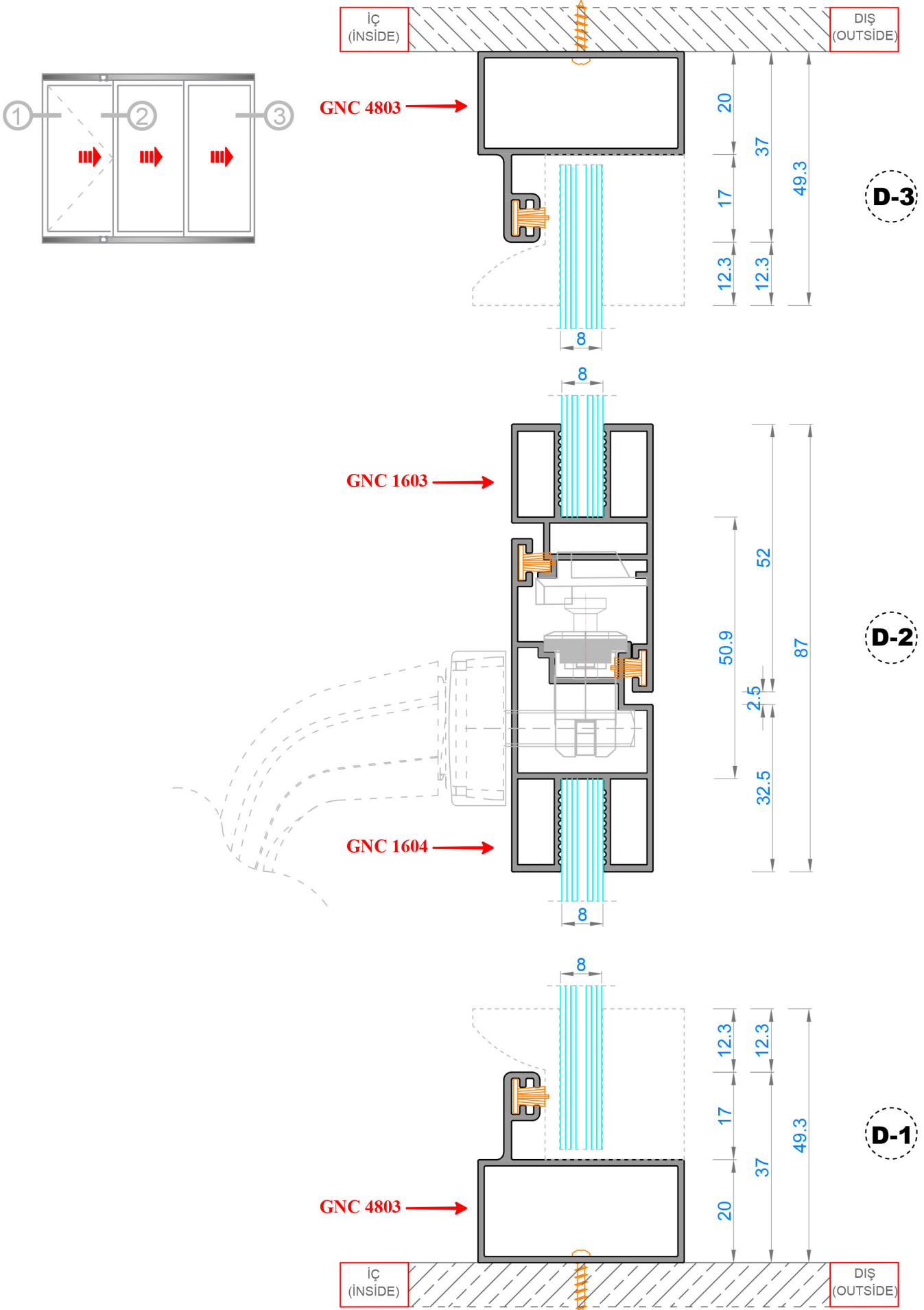













Profil Kod: 4805

Ağırlık (kg/mt) 0,137







	DÜZ BAZA KAPAK SAĞ-SOL		SAĞ BOYNUZ		İSPANYOLET
	90° ALT-ÜST KAPAK SAĞ-SOL		SOL BOYNUZ		İspanyolet Karşılık
	BAZA BİTİŞ KAPAĞI		DÜZ TEKER		3'lü Bakla
	22,5° ALT-ÜST KAPAK SAĞ-SOL		KİLİTLİ TEKER		5'li Bakla
	KIL FİTİL		TEKER ÇIKIŞ PLASTİĞİ		8'li Bakla
	Zero Akustik İspanyolet Kol		ÇIKIŞ KAPAĞI		10'lı Bakla
	DİKME APARATI		MENTEŞELER		Conta

## Platin 8mm Katlanır Cam

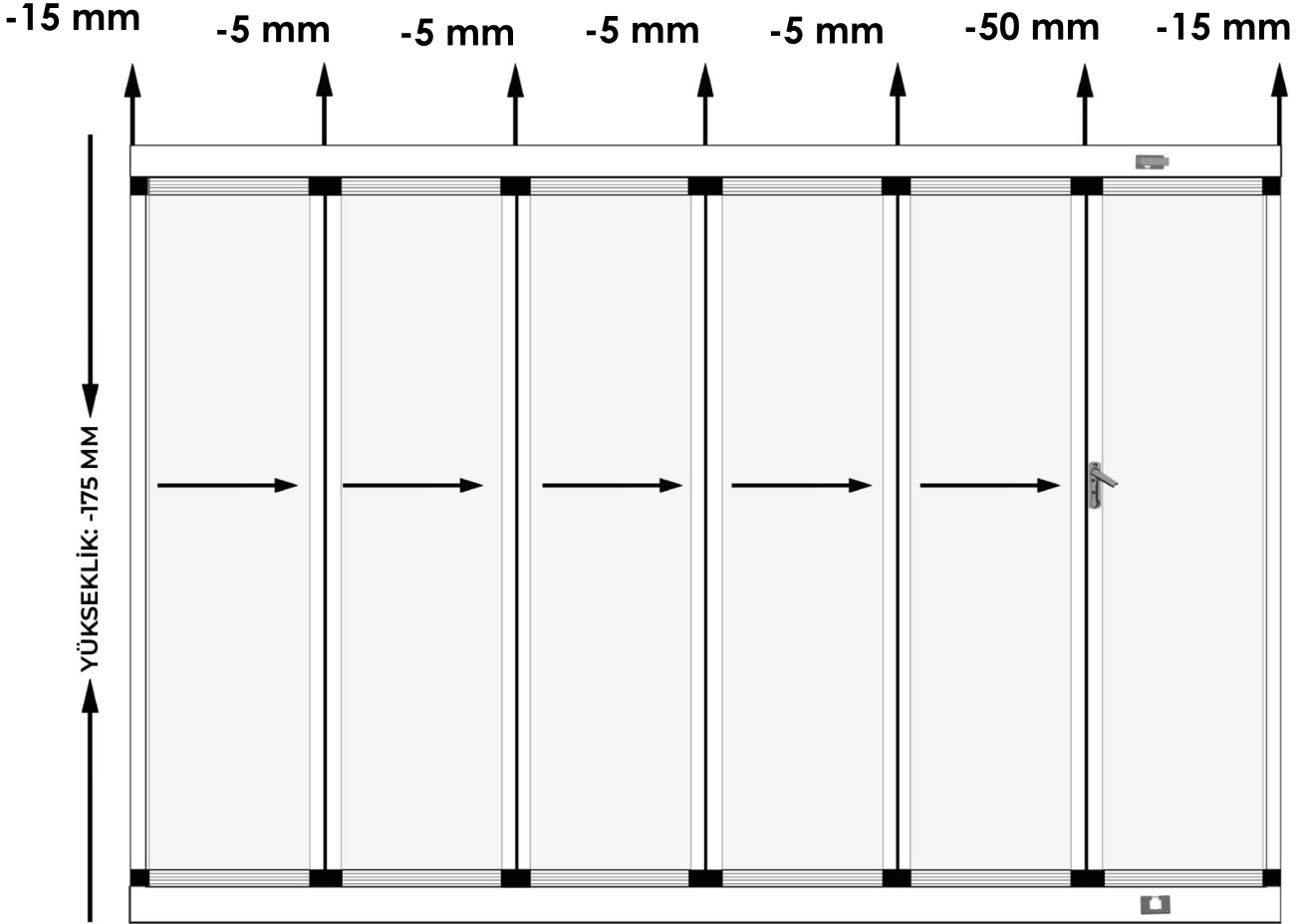

### Kesim Ölçüleri

**1601 Alt Üst Kasa:** Sistem en ölçüsünde kesilir.

**4827 Yan Dikme Kasa:** Sistem yükseklik(h) ölçüsünden -130 mm düşülerek kesilir.

**Cam:** Sistem yüksekliğinden(h) -175 mm düşülerek cam ölçüsü çıkartılır.